



## Main Features

- Intel® Apollo Lake J3455 processor
- Slim chassis design
- Support 2 x HDMI 1.4b output
- Support power input 12 VDC
- Fanless design
- 1 x DDR3L up to 8GB, M.2 2242 Key M for storage device
- mini-PCIe slot support Wi-Fi and LTE module

## Product Overview

Powered by Intel® Apollo Lake processor, the Neu-X101 fanless embedded player can handle 2 independence display output. The Neu-X101 supports HDMI display, USB 3.0 ports, and a RS232/RS422/RS485 interface, is an ideal embedded player to optimize information visualization, convey brand messages, customer engagement, and smart retail management efficiencies to increase in-store traffic and sales. Also could be applicable as gateway for smart city. The slim fanless design with extended durability further covers usages like endless aisles, QSRs, drive-thru kiosks, bus stops, digital transit information signs, and information stands.

## Specifications

### CPU Support

- Intel® Apollo Lake J3455 processor (2.30GHz, 10W)

### Graphic & Display

- Intel® HD Graphics 500

### Main Memory

- 1 x 204-pin SO-DIMM socket, support up to DDR3L 1600MHz, non-ECC, un-buffered memory up to 8GB

### I/O Interface-Front

- 2 x RJ45 with LEDs for Gigabit LAN
- 2 x HDMI 1.4b, resolution 3840 x 2160 30Hz
- 2 x USB 3.0
- 2 x USB 2.0
- 1 x Power button with LED
- 1 x DC-in Jack with lock

### I/O Interface-Rear

- 2 x Antenna hole
- 1 x COM port (RS232/RS422/RS485)
- 1 x Storage active LED

### Internal I/O

- 1 x COM port connector (RS232, RI/5V/12V)
- 1 x TPM module connector
- 1 x Line-out audio connector

### Expansion

- 1 x mini-PCIe full-size connector with SIM slot (nano) onboard, support Wi-Fi/LTE module

### Storage

- 1 x M.2 2242 Key M

### Power Supply

- 1 x External 60W AC/DC power adapter (power adapter is included in accessory)
- Input: 100VAC to 240VAC
- Output: DC+12VDC

### Environment

- Operating temperature: -5°C to 50°C ambient with air flow
- Humidity: 95% (non-condensing)
- Storage temperature: -20°C to 80°C
- Shock protection: 50G peak acceleration, 11ms according to

## Dimension Drawing

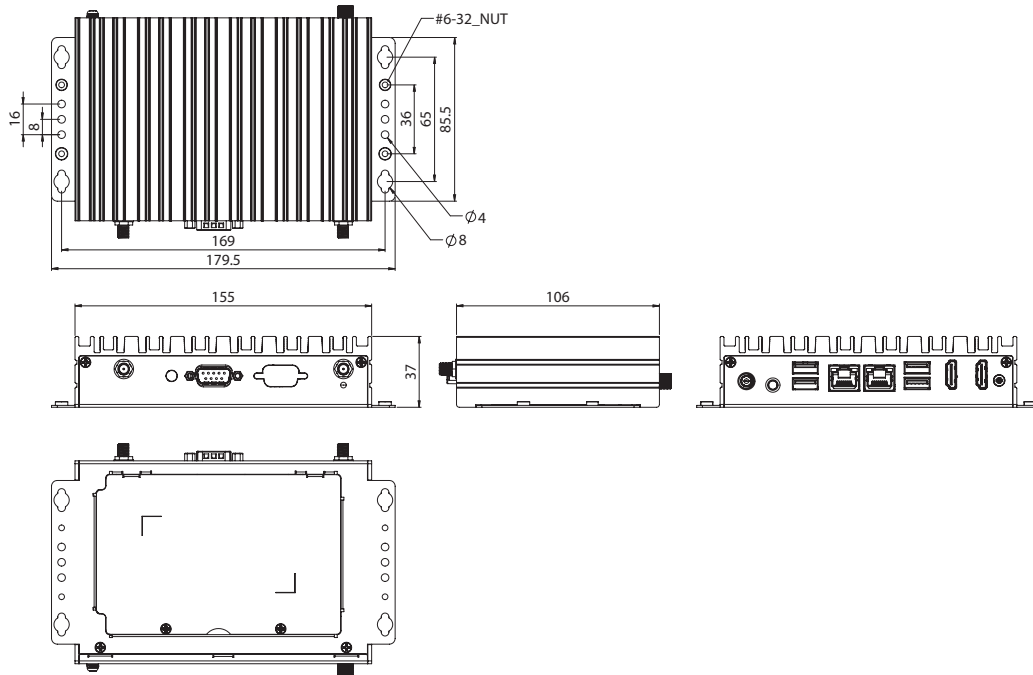

- IEC60068-2-27
- Vibration protection
  - Random: 2Grms @ 5~500 Hz, IEC60068-2-64
  - Sinusoidal: 2G @ 5~500 Hz, IEC60068-2-6

### Mechanical & Dimension

- Aluminum and metal chassis with fanless design
- 179.5mm (W) x 106mm (D) x 37mm (H)

### Certification

- CE (EN55035 + EN55032)
- FCC Class A (EMI part 15B)
- LVD (EN62368-1)

### Operating System

- Win10 64-bit
- Linu x 4.1

## Ordering Information

- ♦ **Neu-X101 (P/N: 10W10X10100X0)**  
Intel® Apollo Lake J3455 processor slim and fanless system

### AI Booster Card

- ♦ **AIBooster®-X1 (P/N: 88W10X10000X0)**  
Intel® Movidius™ Myriad™ X VPU, mini-PCIe module (1 x MA2485)
- ♦ **AIBooster®-X2 (P/N: 88W10X10001X0)**  
Intel® Movidius™ Myriad™ X VPU, mini-PCIe module (2 x MA2485)